

IDEAL STANDARD & CERAMICA DOLOMITE

# CATALOGO RICAMBI 2020 CABINE DOCCIA



Ideal Standard



**CATALOGO RICAMBI**  
CABINE DOCCIA

4	Principali tipologie di apertura
13	Magnum
14	Strada
16	Kubo
19	Connect 2
24	Connect
26	Tipica

Cabine doccia

# Modello A - apertura ad angolo

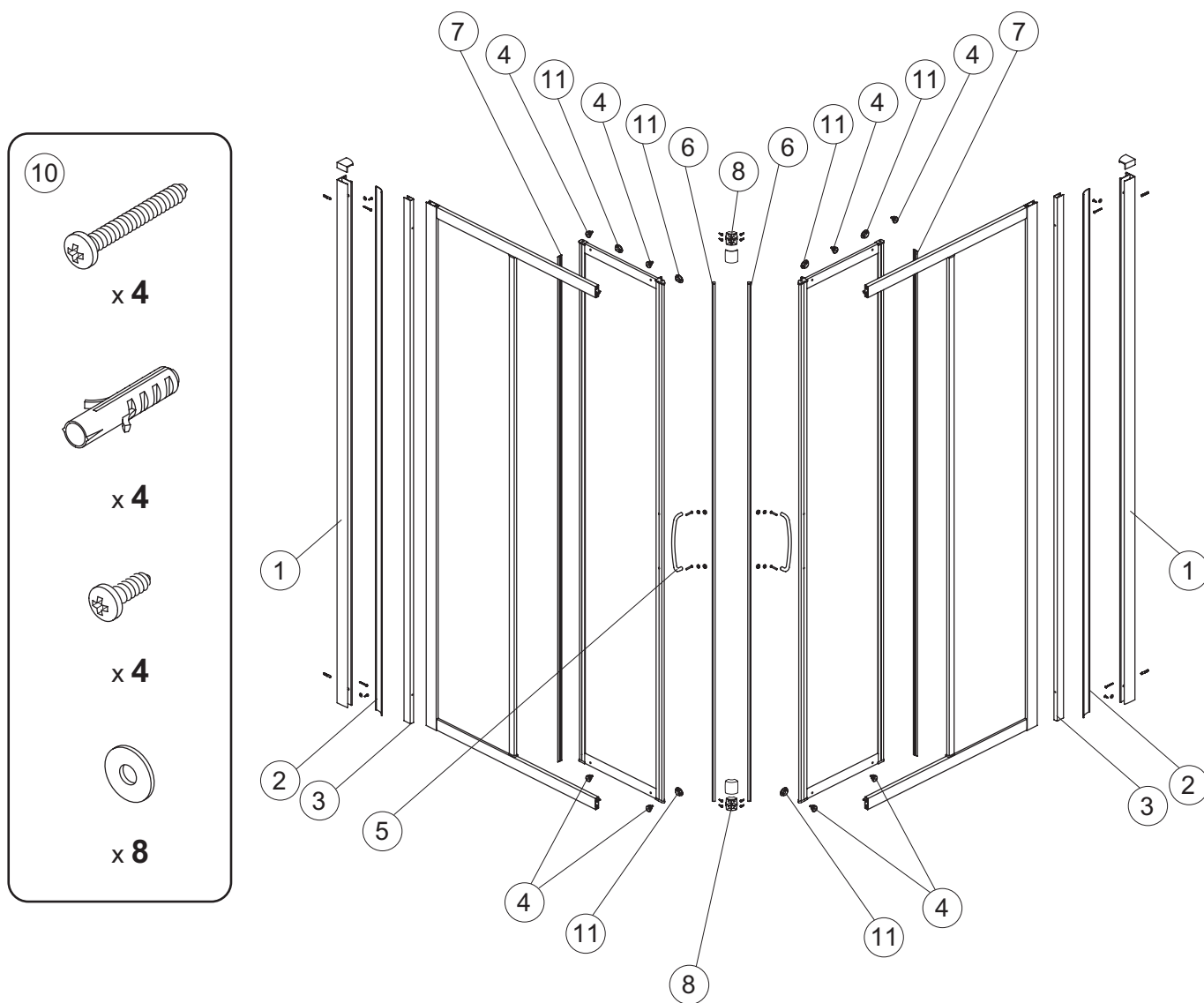

Pos.	Descrizione
1	Profilo fissaggio a muro
2	Profilo copriviti (Carter)
3	Profilo allungamento 25 mm
4	Supp. Cuscinetto
5	Maniglia c/fori interasse 192 mm
6	Guarnizione maniglia

Pos.	Descrizione
7	Guarnizione verticale
8	Raccordo angolare
9	Confezione accessori di montaggio
10	Confezione viti e tasselli
11	Coperchio

Cabine doccia

# Modello R - apertura ad angolo curvo

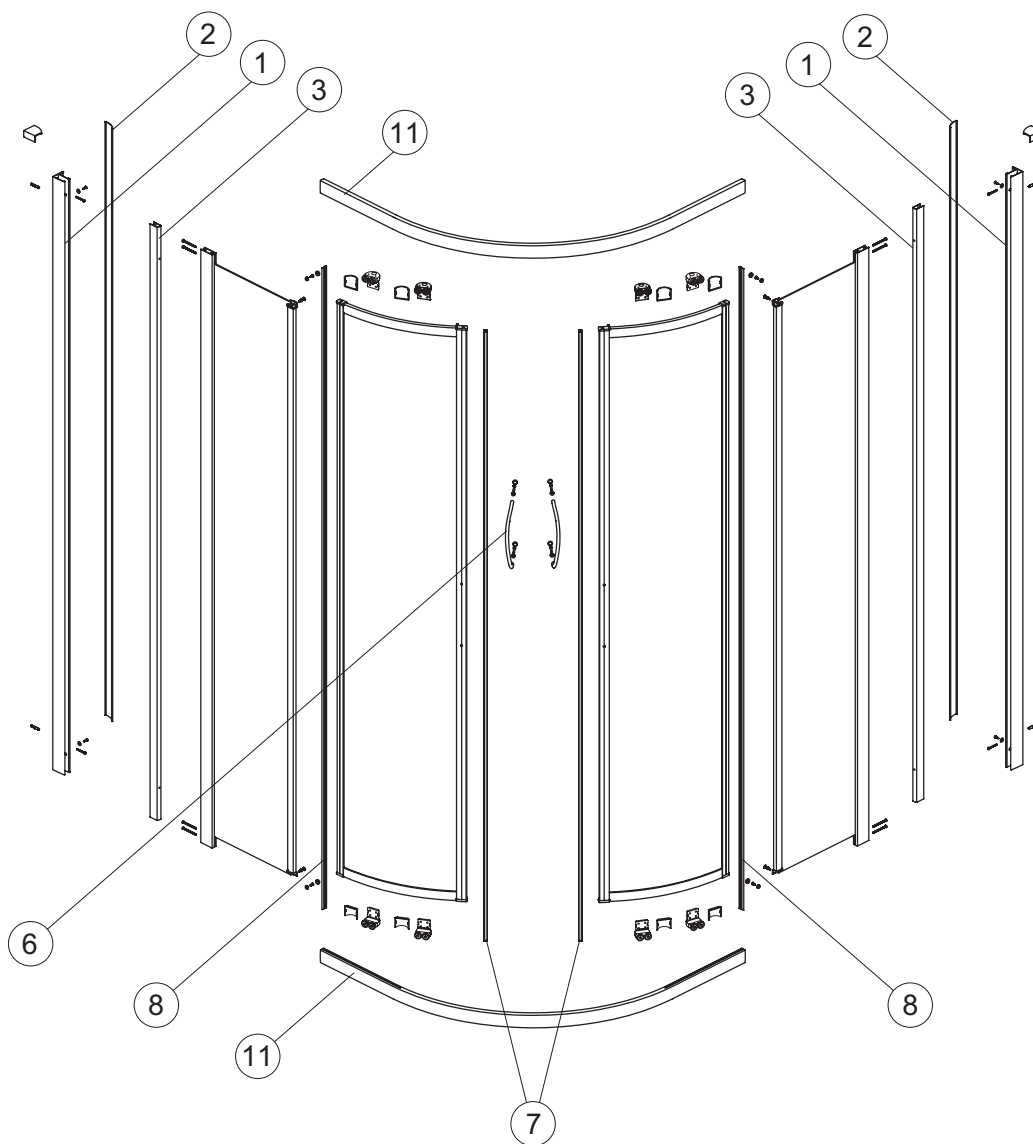
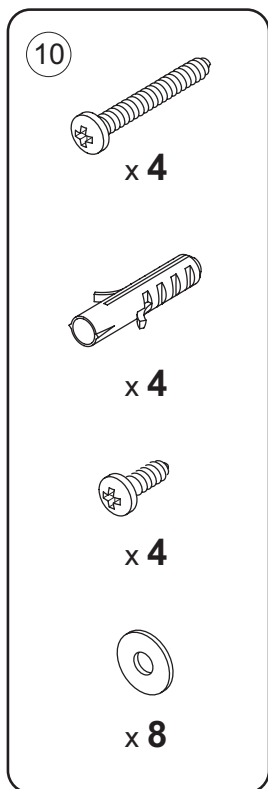
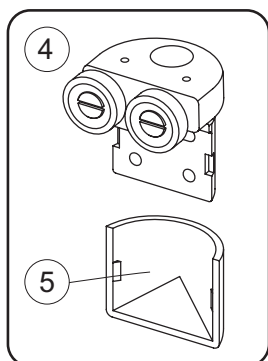

Pos.	Descrizione
1	Profilo fissaggio a muro
2	Profilo copriviti (Carter)
3	Profilo allungamento 25 mm
4	Supp. Cuscinetto
5	Coperchio porta cuscinetto
6	Maniglia c/fori interasse 192 mm

Pos.	Descrizione
7	Guarnizione maniglia
8	Garnizione verticale
9	Confezione accessori di montaggio
10	Confezione viti e tasselli
11	Binario

Cabine doccia

# Modello PV - apertura con anta pivottante

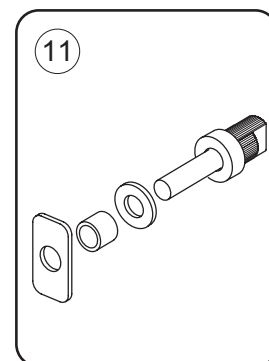
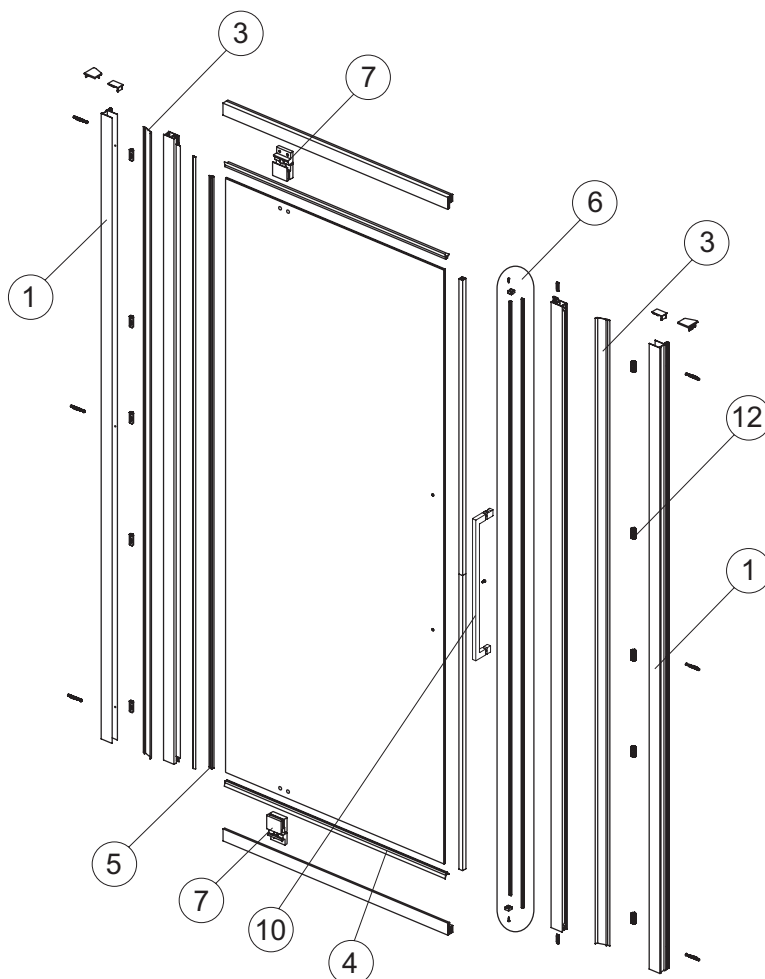
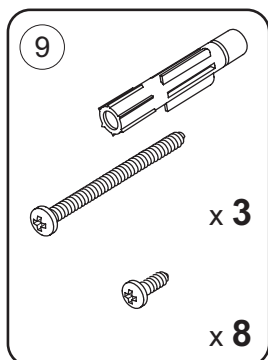
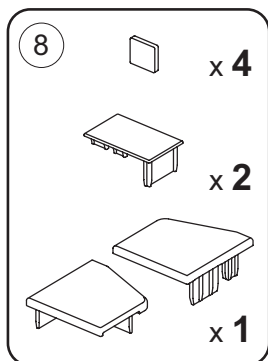
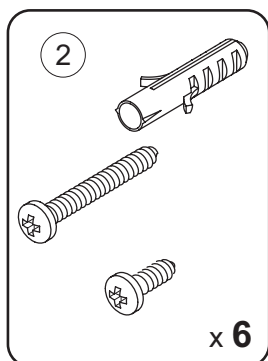

Pos.	Descrizione
1	Profilo fissaggio a muro
2	Set completo viti per profilo muro
3	Profilo copriviti (Carter)
4	Guarnizione gocciolatoio
5	Guarnizione verticale
6	Coppia guarnizioni magnetiche + tappi

Pos.	Descrizione
7	Cerniera con viti fissaggio
8	Set tappi copertura
9	Confezione viti e accessori di montaggio
10	Maniglia cromo completa di viti
11	Viti e guarnizioni per maniglia
12	Blocchetto di fissaggio per carter

Cabine doccia

# Modello PS - apertura con anta a soffietto

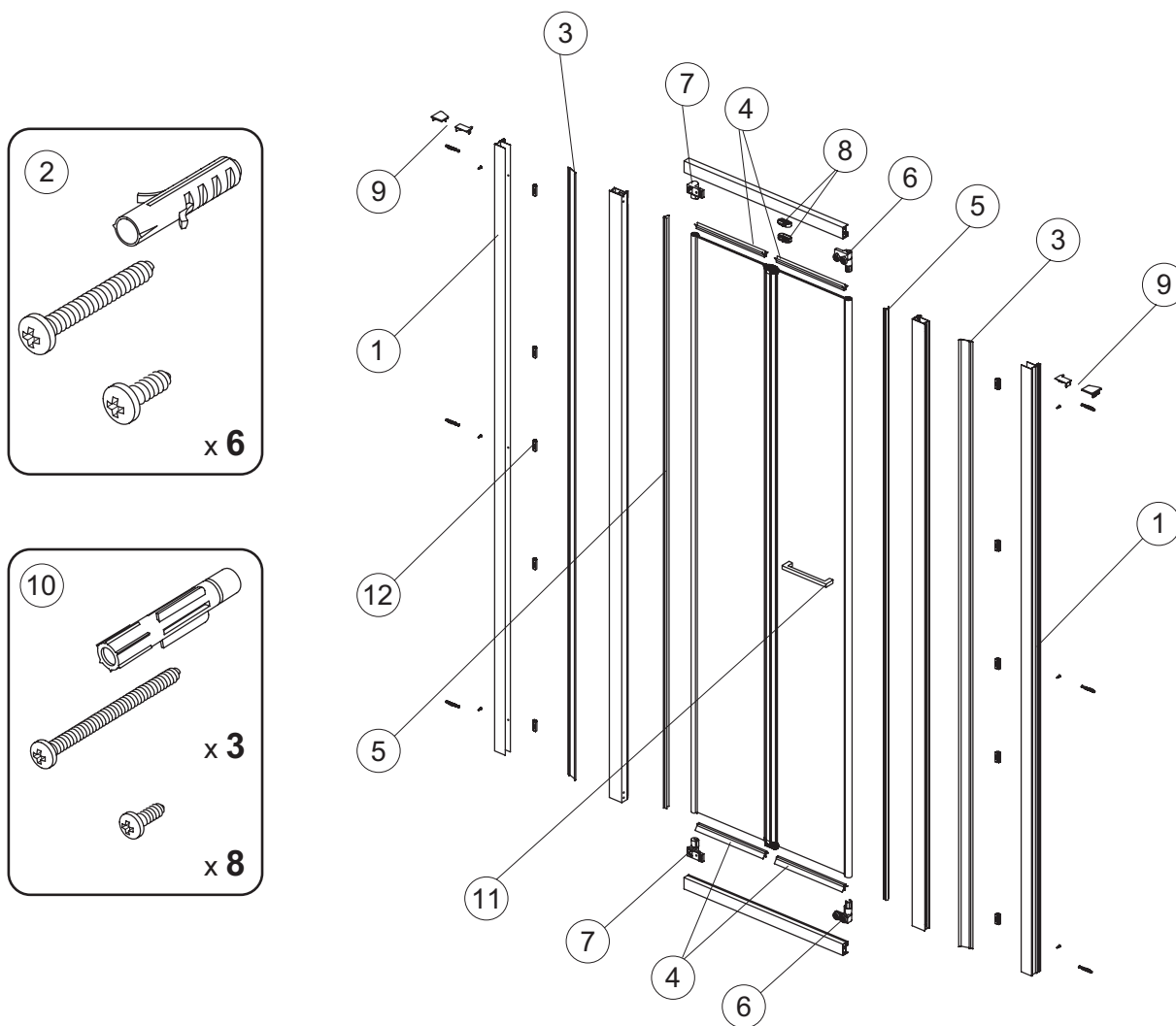

Pos.	Descrizione
1	Profilo fissaggio a muro
2	Set completo viti per profilo muro
3	Profilo copriviti (Carter)
4	Guarnizione gocciolatoio
5	Guarnizione verticale
6	Set cerniere fissa + stopper

Pos.	Descrizione
7	Set carrello completo
8	Set giunzione centrale
9	Set tappi di copertura
10	Confezione viti e accessori di montaggio
11	Maniglia completa
12	Blocchetto di fissaggio per carter

Cabine doccia

# Modello PSC - apertura con anta scorrevole

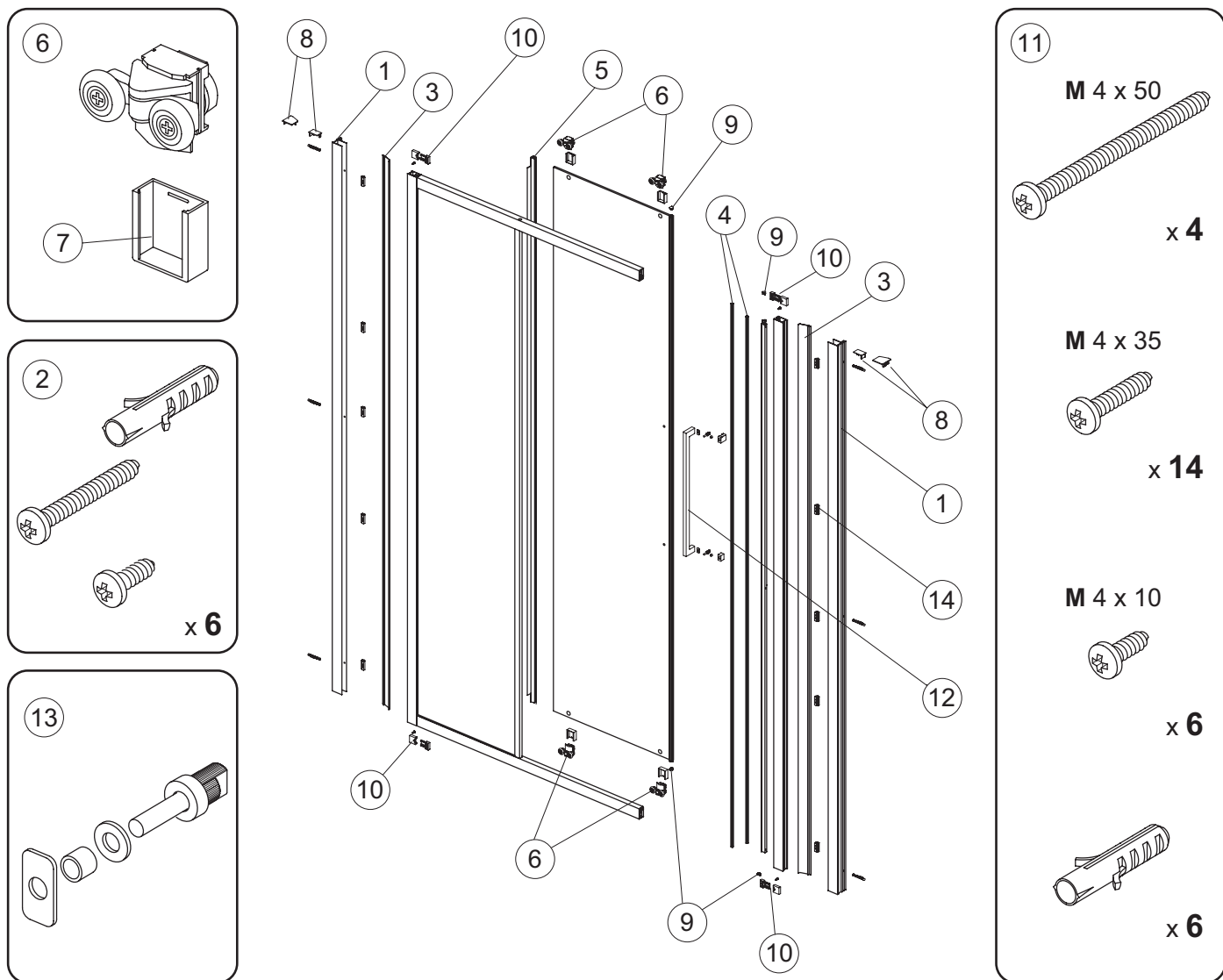

Pos.	Descrizione
1	Profilo fissaggio a muro
2	Set completo viti per profilo muro
3	Profilo copriviti (Carter)
4	Coppia di magneti per scorrimento
5	Guarnizioni contenimento porta
6	Cuscinetto completo
7	Set coperchi cuscinetto

Pos.	Descrizione
8	Set tappi copertura
9	Set tappi copertura maniglia
10	Set fermaporta
11	Confezione viti e accessori di montaggio
12	Maniglia cromo completa
13	Kit viti e guarnizioni per maniglia
14	Blocchetto di fissaggio per carter



Cabine doccia

# Modello PSC2 - apertura con anta scorrevole centrale

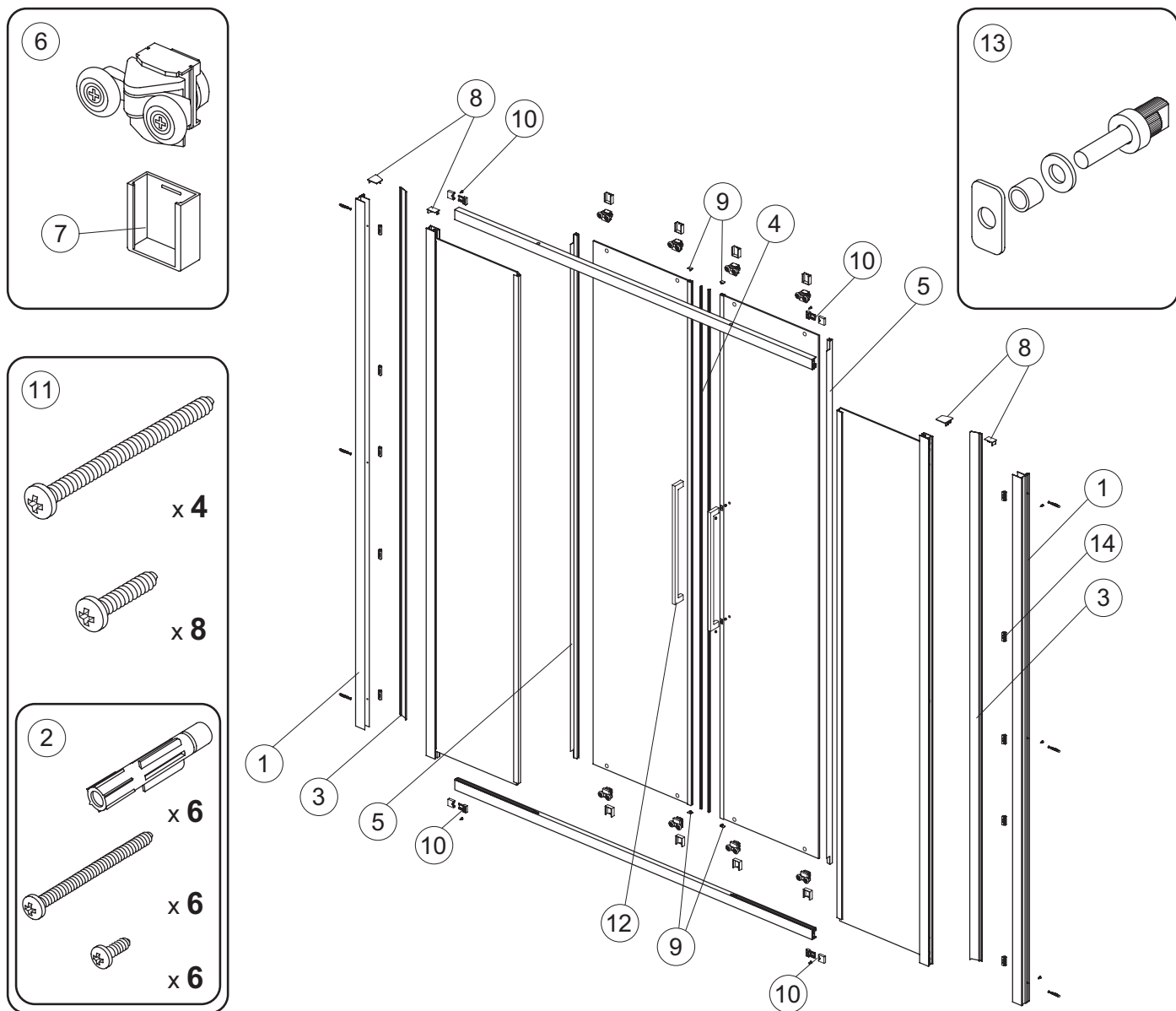

Pos.	Descrizione
1	Profilo fissaggio a muro
2	Set completo viti per profilo muro
3	Profilo copriviti (Carter)
4	Coppia di magneti
5	Guarnizione contenimento porta
6	Cuscinetto completo
7	Set coperchi cuscinetto

Pos.	Descrizione
8	Set tappi copertura
9	Set tappi copertura maniglia
10	Set fermaporta
11	Confezione viti e accessori di montaggio
12	Maniglia cromo completa di viti
13	Kit viti e guarnizioni per maniglia
14	Bloccetto di fissaggio per carter

Cabine doccia

# Modello P - apertura con ante scorrevoli

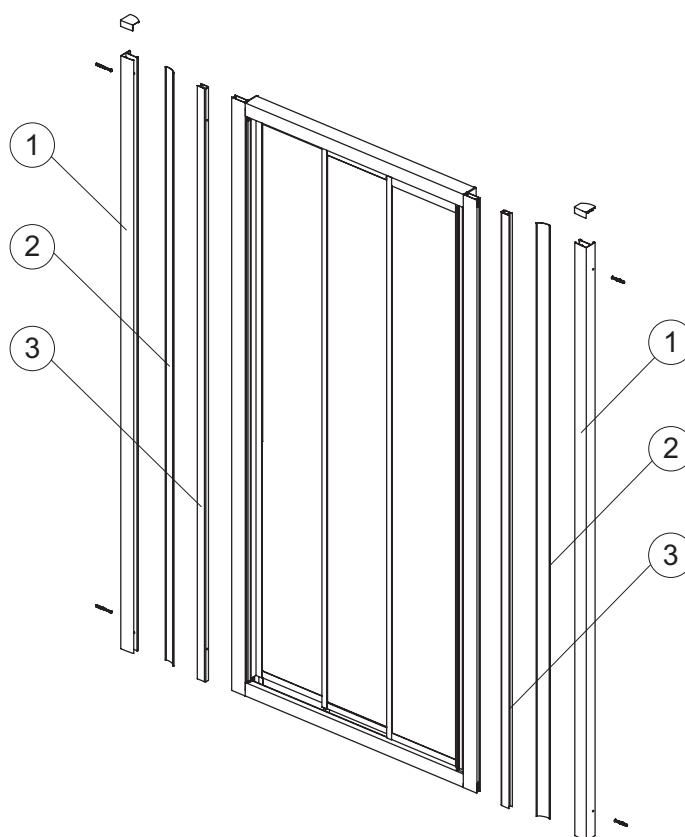
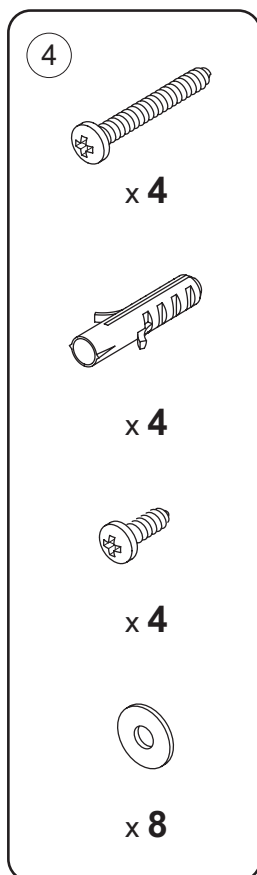

Pos.	Descrizione
1	Profilo fissaggio a muro completo
2	Profilo copriviti (Carter) in PVC
3	Profilo compensativo 25 mm
4	Confezione viti e accessori di montaggio

Cabine doccia

# Modello S - apertura con ante battenti (tipo saloon)

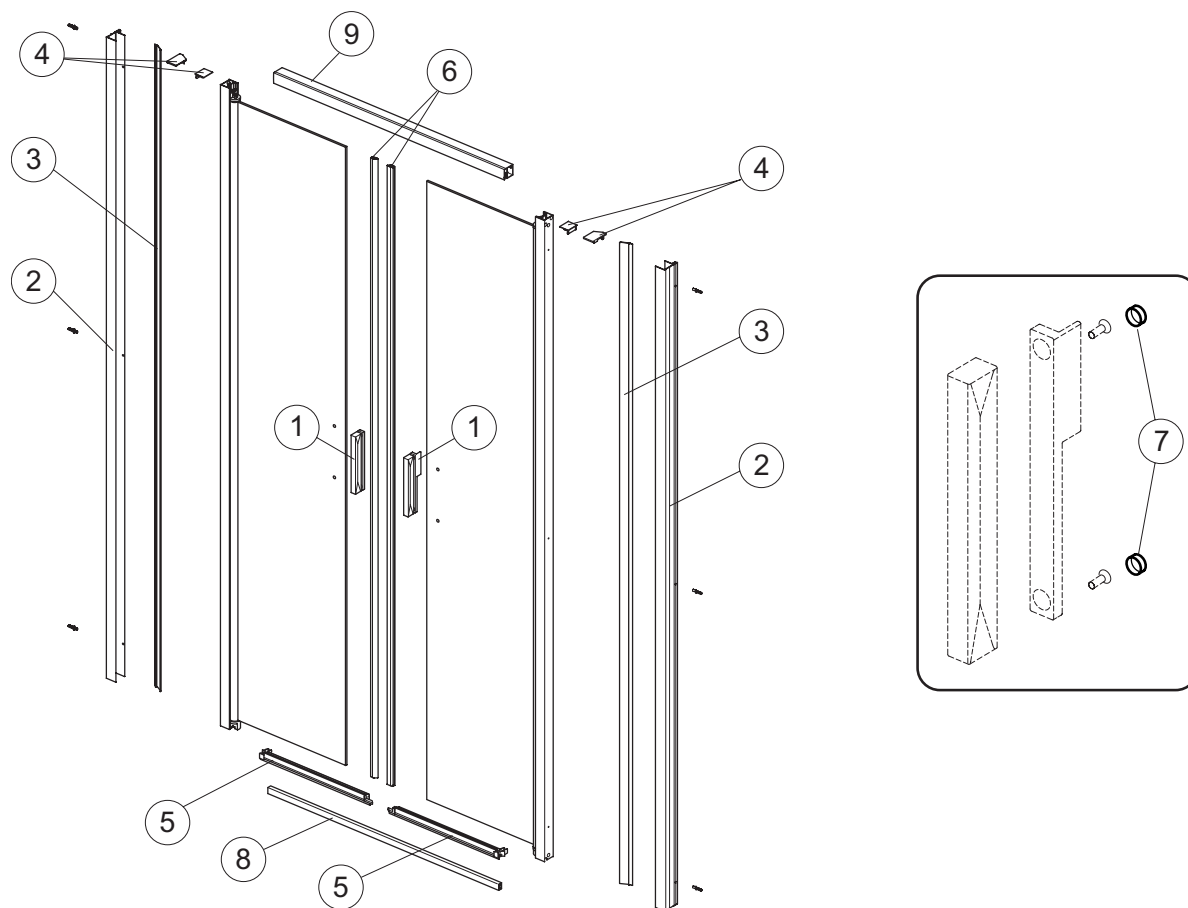

Pos.	Descrizione
1	Kit maniglia
2	Kit per profilo muro c
3	Profilo carter muro tgl 2000
4	Set tappi di copertura
5	Easy kit profilo gocciolatoio

Pos.	Descrizione
6	Guarnizione magnetica
7	Tappo maniglia cromato
8	Barra inferiore
9	Barra superiore

Cabine doccia

# Modello L - laterale fisso

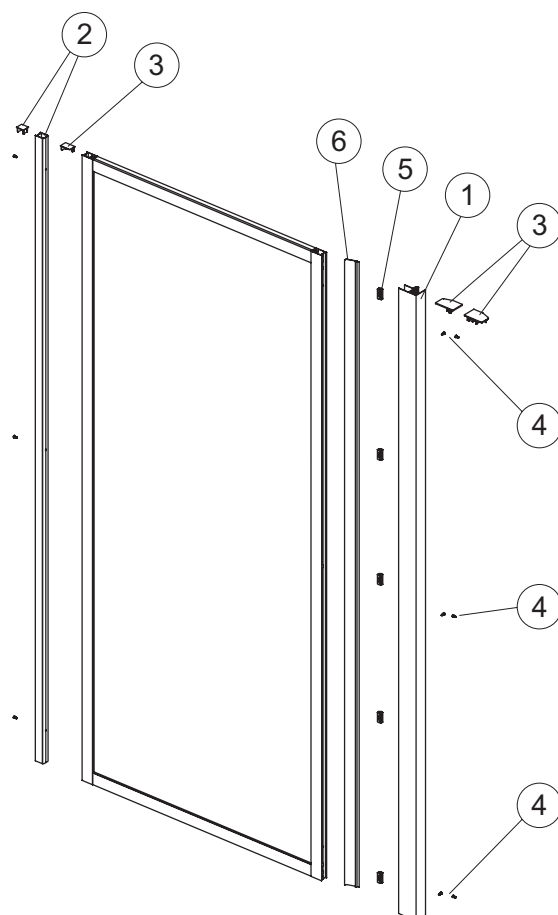











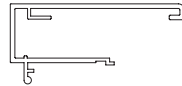

Pos.	Descrizione
1	Profilo fissaggio a muro
2	Profilo compensativo 25 mm
3	Set tappi copertura

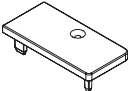
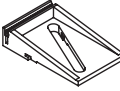
Pos.	Descrizione
4	Confezione viti e accessori di montaggio
5	Blocchetto di fissaggio per carter
6	Profilo coprivite

# Cabine doccia

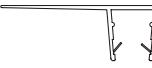
## Magnum



DISPONIBILE SINO AD ESAURIMENTO SCORTE

Descrizione	Note	Disegno	Colore	Codice
Profilo verticale di fissaggio a muro	1 dx + 1 sx h = 200 cm		Brill Lucido	T000992YE
Profilo di fissaggio Magnum PSC	1 pz h = 200 cm		Brill Lucido	T000994YE
Profilo verticale copriviti	1 dx + 1 sx h = 200 cm		Brill Lucido	T000993YE
Profilo verticale copriviti battuta Magnum PSC	1 pz h = 200 cm		Brill Lucido	T000995YE
Maniglia completa	1 pz		Cromo	T001399AA
Tappo montante per anta fissa	1 dx + 1 sx		Brill Lucido	T001001YE
Blocchetto di regolazione per bloccaggio vetro fisso	8 pz		Brill Lucido	T001000YE
Guarnizione magnetica Magnum Angolo	una coppia h = 200 cm			T000998NU
Guarnizione magnetica Magnum PSC porta per nicchia	una coppia h = 200 cm			T000999NU
Guarnizione verticale di chiusura Magnum PSC+L	1 pz h = 200 cm			T000996NU
Guarnizione verticale tra anta fissa e scorrevole	1 pz h = 200 cm			T000997NU
Sacchetto viti di fissaggio Magnum PSC+L				T001002NU
Sacchetto viti di fissaggio Magnum PSC				T001003NU
Sacchetto viti di fissaggio Magnum A				T001004NU

## Cabine doccia

**Strada**

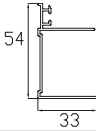
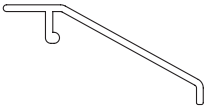
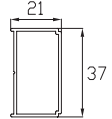
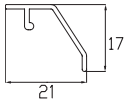
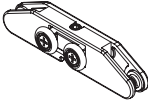
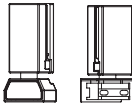
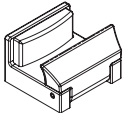
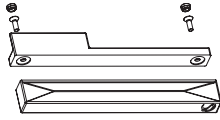

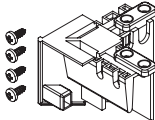
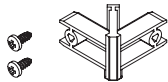



DISPONIBILE SINO AD ESAURIMENTO SCORTE

Descrizione	Note	Disegno	Colore	Codice
Profilo verticale di fissaggio a muro Strada	1 pz h = 200 cm		Brill Lucido Argento Sat. Bianco matt	TV200EO TV200EM TV200EN
Profilo verticale copriviti	1 pz h = 200 cm		Brill Lucido Argento Sat. Bianco matt	TV201EO TV201EM TV201EN
Profilo aggiuntivo di allungamento 20 mm Strada	1 pz h = 200 cm		Brill Lucido Argento Sat. Bianco matt	TV203EO TV203EM TV203EN
Profilo verticale copriviti per giunzione angolo Strada L	1 pz h = 200 cm		Brill Lucido Argento Sat. Bianco matt	TV202EO TV202EM TV202EN
Carrello di scorrimento a 2 ruote Strada A, PSC	1 pz		Cromo	TV220AA
Kit cerniera completo Strada R, PV	1 sup. + 1 inf.		Cromo	TV217AA
Kit completo Click&Clean Strada A, PSC	1 pz		Cromo	TV219AA
Maniglia completa	1 pz		Cromo Bianco matt	TV216AA TV216EN
Tappi di finitura per Strada	1 pz		Cromo	TV218AA
Kit fermaporta Strada A, PSC	2 pz		Cromo	TV222AA
Giunzione ad angolo superiore per Strada A	1 pz		Cromo	TV224AA
Giunzione ad angolo inferiore per Strada A	1 pz		Cromo	TV223AA

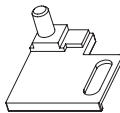
## Cabine doccia

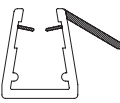
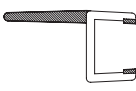
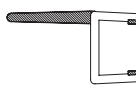

**Strada**

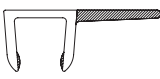
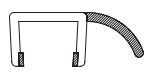
DISPONIBILE SINO AD ESAURIMENTO SCORTE

Descrizione	Note	Disegno	Colore	Codice
Blocchetto di fissaggio inferiore vetro fisso Strada A, PSC	1 dx + 1 sx		Cromo	TV221AA
Guarnizione magnetica morbida per Strada A, R e S	una coppia h = 200 cm		Trasparente	TV226TS
Guarnizione magnetica morbida per Strada R e PV	1 pz h = 200 cm		Trasparente	TV351TS
Guarnizione magnetica morbida per Strada PSC	1 pz h = 200 cm		Trasparente	TV313TS
Guarnizione inferiore anta Strada A, PSC	2 pz h = 200 cm		Trasparente	TV229TS
Guarnizione inferiore anta Strada R	2 pz h = 100 cm		Trasparente	TV352TS
Guarnizione inferiore anta Strada PV	1 pz h = 200 cm		Trasparente	TV227TS
Guarnizione inferiore anta Strada S	2 pz h = 100 cm		Trasparente	TV225TS
Guarnizione verticale di contenimento Strada A, PSC	2 pz h = 200 cm		Trasparente	TV230TS
Guarnizione verticale di contenimento Strada R, PV	2 pz h = 200 cm		Trasparente	TV228TS

## Cabine doccia

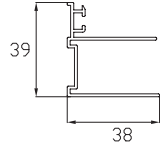
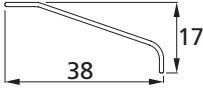
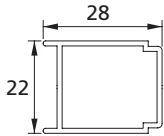
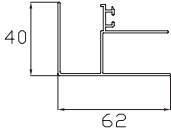
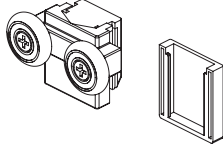
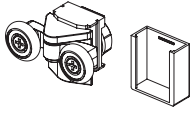
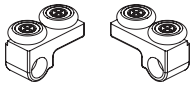
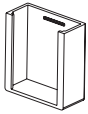

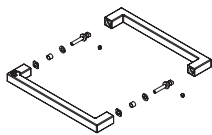



**Kubo**

Descrizione	Note	Disegno	Colore	Codice
Profilo verticale di fissaggio a muro	1 pz h = 195 cm		Brill Lucido	T001172EO
Profilo verticale copriviti	1 pz h = 195 cm		Brill Lucido	T001100EO
Profilo aggiuntivo di allungamento 25 mm	1 pz h = 195 cm		Brill Lucido	T001095EO
Profilo giunzione ad angolo Kubo L	1 pz h = 195 cm		Brill Lucido	T001094EO
Cuscinetto con copertura per Kubo A e PSC2	1 pz		Brill Lucido	T001174NU
Cuscinetto con copertura per Kubo R e PSC	1 pz		Brill Lucido	T001173NU
Cuscinetto per Kubo PS	1 dx + 1 sx		Cromo	T001228AA
Copertura cuscinetto per Kubo A e R	8 pz		Brill Lucido	T001099EO
Maniglia completa Kubo A, R, PV, PSC, PSC2	1 pz		Cromo	T001184AA
Maniglia completa Kubo PS	1 pz		Cromo	T001231AA



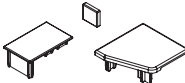

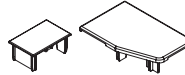
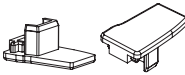
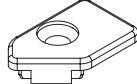
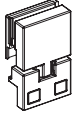
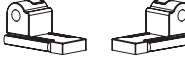

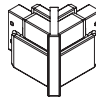
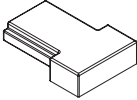
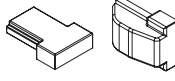
## Cabine doccia

## Kubo

Descrizione	Note	Disegno	Colore	Codice
Tappi di finitura per profilo a muro Kubo R	2 dx + 2 sx		Brill Lucido	T001097NU
Tappi di finitura per profilo a muro Kubo A, R, PSC, PSC2	3 dx + 3 sx		Brill Lucido	T001096NU
Tappi di finitura per profilo a muro Kubo PV	1 dx + 1 sx		Brill Lucido	T001236EO
Tappi di finitura per profilo a muro Kubo PS	2 dx + 2 sx		Brill Lucido	T001230EO
Tappi di finitura per profilo angolare Kubo L	2 dx + 2 sx		Brill Lucido	T001105NU
Tappi di finitura per profilo magnetico Kubo R	2 dx + 2 sx		Brill Lucido	T001106NU
Tappi di finitura per profilo magnetico Kubo A	2 dx + 2 sx		Brill Lucido	T001171NU
Cerniera con viti fissaggio Kubo PV	1 pz		Brill Lucido	T001235EO
Cerniera fissa + fermaporta Kubo PS	1 dx + 1 sx		Brill Lucido	T001227AA
Giunzione centrale Kubo PS	1 sup + 1 inf		Brill Lucido	T001229EO
Giunzione ad angolo per Kubo A	1 pz		Brill Lucido	T001175EO
Set fermaporta Kubo R	4 pz		Brill Lucido	T001103NU
Set fermaporta Kubo A	2 pz + 2 pz		Brill Lucido	T001170NU

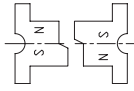
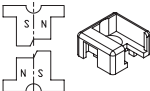

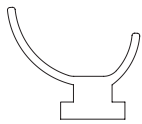
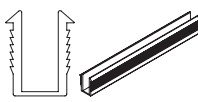
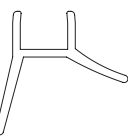
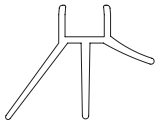

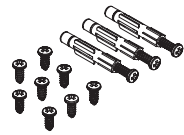
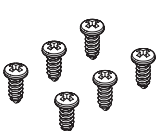

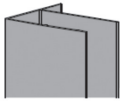
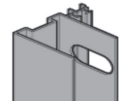

## Cabine doccia

## Kubo

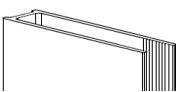
Descrizione	Note	Disegno	Colore	Codice
Guarnizione magnetica per Kubo A, R, PSC, PSC2	una coppia h = 195 cm			T001098EO
Guarnizione magnetica per Kubo PV con tappi terminali	1 dx + 1 sx			T001234NU
Guarnizione verticale contenimento Kubo A, PSC, PSC2	1 pz h = 200 cm			T001374NU
Guarnizione verticale di contenimento Kubo PS	2 pz h = 195 cm			T001226NU
Guarnizione fermavetro Binario Kubo R	1 pz h = 100 cm			T001373NU
Guarnizione gocciolatoio Kubo PV	1 pz h = 100 cm			T001232NU
Guarnizione gocciolatoio Kubo PS	1 pz h = 100 cm			T001375NU
Set completo viti per profilo muro				T001104NU
Confezione viti e accessori montaggio Kubo R				T001182NU
Confezione viti e accessori montaggio Kubo A				T001183NU
Confezione viti e accessori montaggio Kubo L				T001186NU

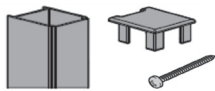

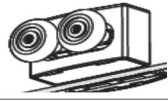
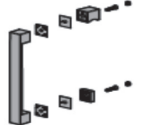
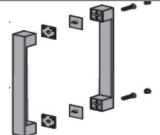

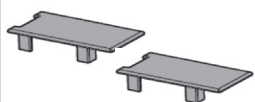
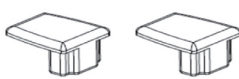

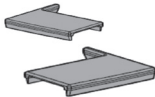

Cabine doccia

# Connect 2

Descrizione	Note	Disegno	Colore	Codice
Profilo verticale di fissaggio a muro per Connect 2 A, R, PSC, PSC2, PV, S, L	1 pz h = 195 cm			KV177EO
Profilo verticale di fissaggio a muro per Connect 2 V	1 pz			KV274EO
Profilo verticale copriviti per Connect 2 V	1 pz			KV275EO
Profilo verticale di fissaggio a muro per Connect 2 W	1 pz			KV243EO
Profilo di giunzione ad angolo per Connect 2 L	1 pz			KV241EO
Profilo aggiuntivo di allungamento 25 mm completo di tappo di finitura e viti di fissaggio per Connect 2 (tutti i modelli)	1 pz			KV227EO
Cuscinetto superiore per Connect 2 A, R, PSC, PSC2	1 pz		Cromo	KV211AA
Cuscinetto inferiore per Connect 2 A, R, PSC, PSC2	1 pz		Cromo	KV212AA
Maniglia completa per Connect 2 A	1 pz		Cromo	KV195AA
Maniglia completa per Connect 2 R, PSC, PSC2, PV, S	1 pz		Cromo	KV194AA
Maniglia completa per Connect 2 PS	1 pz		Cromo	KV286AA
Tappi di finitura per profilo verticale Connect 2 A, R, PSC, PSC2, PS, PV, S, L	2 pz		Cromo	KV197AA
Tappi di finitura per profilo magnetico Connect 2 R, PSC2	1 sup + 1 inf		Cromo	KV209AA

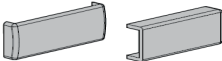
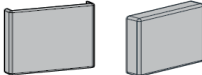
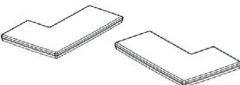

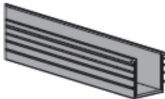
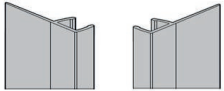
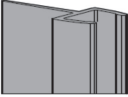

Cabine doccia

# Connect 2

Descrizione	Note	Disegno	Colore	Codice
Tappi di finitura per profilo verticale di fissaggio a muro per Connect 2 A, R, PSC, PSC2, PV, S	1 dx + 1 sx		Cromo	KV198AA
Coppia di tappi di finitura profilo per Connect 2 A, PSC	1 sup + 1 inf		Cromo	KV210AA
Tappo di finitura per profilo aggiuntivo di allungamento Connect 2 A	1 pz		Cromo	KV228AA
Tappi di finitura per profilo a muro Connect 2 V	1 dx + 1 sx			KV276AA
Tappo per profilo verticale Connect 2 W	1 pz		Cromo	KV245AA
Tappi per barra di sostegno obliqua Connect 2 W	2 pz			KV248AA
Tappi per barra di sostegno verticale Connect 2 W	1 pz			KV250AA
Tappi di finitura per profilo angolare per Connect 2 L	1 dx + 1 sx			KV240AA
Coppia di tappi per guarnizione magnetica per Connect 2 PSC, PV	1 pz		Cromo	KV199AA
Coppia di tappi di copertura per maniglia Connect 2 A, R, PSC, PSC2, PV, S	1 pz		Cromo	KV196AA
Guarnizione orizzontale fermavetro Connect 2 A, R, PSC, PSC2	1 pz h = 80 cm			KV22667
Guarnizione verticale per anta fissa e scorrevole per Connect 2 A, PSC, PSC2	1 per porta h 193 cm + 1 per profilo 187 cm			KV20567
Guarnizione verticale per Connect 2 PV	1 pz h = 185 mm			KV17967
Guarnizione di finitura profilo Connect 2 PV	1 pz h = 185 mm			KV178AH



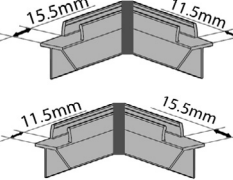
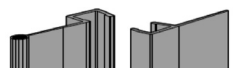

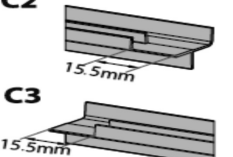

# Cabine doccia

## Connect 2

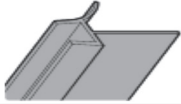
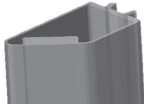
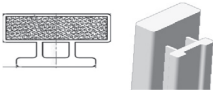
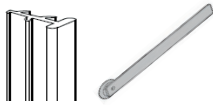
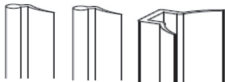
Descrizione	Note	Disegno	Colore	Codice
Guarnizione magnetica per Connect 2 PV	1 pz h = 195 mm			KV190AH
Guarnizione magnetica per Connect 2 PV	1 pz h = 193 cm			KV191AH
Guarnizione gocciolatoio per Connect 2 PV	PV 70 1 Dx + 1 Sx l = 58 cm			KV18367
	PV 75 1 Dx + 1 Sx l = 63 cm			KV18467
	PV 80 1 Dx + 1 Sx l = 68 cm			KV18567
	PV 85 1 Dx + 1 Sx l = 73 cm			KV18667
	PV 90 1 Dx + 1 Sx l = 78 cm			KV18767
	PV 95 1 Dx + 1 Sx l = 83 cm			KV18867
	PV 100 1 Dx + 1 Sx l = 88 cm			KV18967
Guarnizione verticale per anta fissa e scorrevole Connect R	1 pz per la porta (h = 193 cm) + 1 pz per il pannello fisso (h = 187 cm)			KV25167
Guarnizione magnetica per Connect 2 S	1 pz h = 185 cm			KV23267
Guarnizione gocciolatoio per Connect 2 S	S 70 1 Dx + 1 Sx l = 27 cm			KV23367
	S 75 1 Dx + 1 Sx l = 30 cm			KV23467
	S 80 1 Dx + 1 Sx l = 32 cm			KV23567
	S 85 1 Dx + 1 Sx l = 35 cm			KV23667
	S 90 1 Dx + 1 Sx l = 37 cm			KV23767
	S 100 1 Dx + 1 Sx l = 42 cm			KV23867

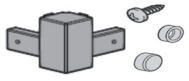
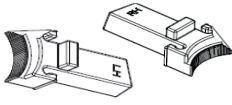
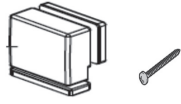
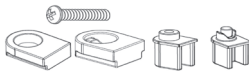
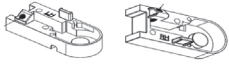

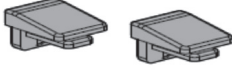
Cabine doccia

## Connect 2

Descrizione	Note	Disegno	Colore	Codice
Guarnizione orizzontale 100 cm per Connect 2 V	1 pz			KV28367
Guarnizione magnetica per anta fissa Connect 2 PSC	1 pz (h = 194 cm)			KV208AH
Guarnizione magnetica per Connect 2 A, R, PSC, PSC2	1 pz h = 193 cm			KV207AH
Guarnizione verticale (200 cm) + kit installazione per Connect 2 W	1 pz			KV244AH
Set di guarnizioni verticali per Connect 2 V	3 pz			KV28267
Set di guarnizioni per Connect 2 S (2 pz)	1 pz (doppio) + 1 pz (singolo)			KV23167
Giunzione ad angolo per Connect 2 A	1 pz			KV229AA
Cerniera Connect 2 V	1 pz			KV278AH
Cerniera con viti di fissaggio per Connect 2 PV	1 pz		Cromo	KV192AA
Cerniera con viti di fissaggio per Connect 2 S	1 pz			KV239AA
Blocco cerniera Connect 2 V	1 pz			KV277AA
Blocchetto di sollevamento Connect 2 V	1 pz			KV280AH
Blocchetto terminale binario Connect 2 A, R, PSC, PSC2	2 pz		Cromo	KV203AA
Set fermaporta per Connect 2 A, R, PSC, PSC2	1 pz		Cromo	KV206AA

# Cabine doccia

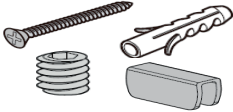
## Connect 2

Descrizione	Note	Modello	Colore	Codice
Kit installazione per Connect 2 V	1 pz			KV28467
Kit installazione per Connect 2 W	4 pz			KV24267
Kit di fissaggi per barra di sostegno verticale Connect 2 W	1 pz			KV24967
Kit di fissaggi per barra sostegno dritta Connect 2 W	1 pz			KV24667
Kit di fissaggi per barra sostegno obliqua Connect 2 W	1 pz			KV24767
Set completo di viti per profilo a muro Connect 2 A, R, PSC, PSC2, PV, S, L	1 pz			KV20167
Set viti di fissaggio per Connect R 2 (4 pz)	1 pz			KV20267

# Cabine doccia

## Connect

DISPONIBILE SINO AD ESAURIMENTO SCORTE

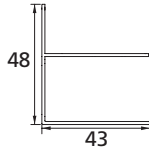
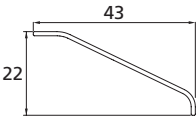
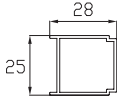
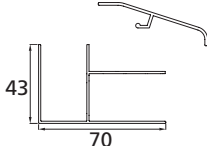
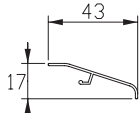
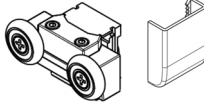
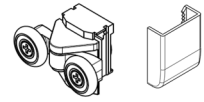
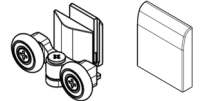
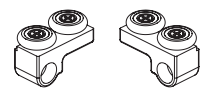
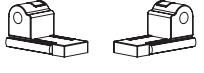
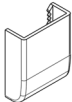





Descrizione	Note	Disegno	Colore	Codice
Profilo verticale di fissaggio a muro	1 pz h = 190 cm		Bianco Brill Lucido	T001289AC T001289EO
Profilo verticale copriviti	1 pz h = 190 cm		Bianco Brill Lucido	T001293AC T001293EO
Profilo aggiuntivo di allungamento 25 mm	1 pz h = 190 cm		Bianco Brill Lucido	T001295AC T001295EO
Profilo giunzione ad angolo Connect L con profilo coprivite	1 pz + 1 pz h = 190 cm		Bianco Brill Lucido	T001313AC T001313EO
Profilo verticale copriviti per giunzione angolo Connect L	1 pz h = 190 cm		Bianco Brill Lucido	T001311AC T001311EO
Cuscinetto con copertura per Connect A e PSC	1 pz + 1 pz		Brill Lucido	T001297EO
Cuscinetto superiore con copertura per Connect R	1 pz + 1 pz		Brill Lucido	T001298EO
Cuscinetto inferiore con copertura per Connect R	1 pz + 1 pz		Brill Lucido	T001299EO
Cuscinetto per Connect PS	1 dx + 1 sx		Cromo	T001228AA
Cerniera fissa + fermaporta Connect PS	1 dx + 1 sx		Brill Lucido	T001227AA
Copertura cuscinetto per Connect A e PSC	4 pz		Brill Lucido	T001292EO

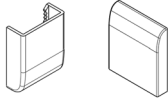
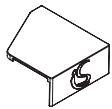
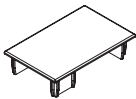

# Cabine doccia

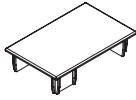
## Connect

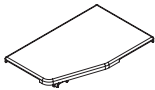
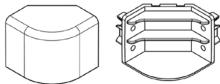
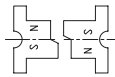

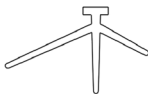
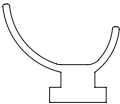
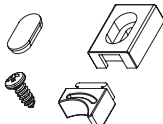

DISPONIBILE SINO AD ESAURIMENTO SCORTE

Descrizione	Note	Disegno	Colore	Codice
Copertura cuscinetto superiore e inferiore per Connect R	4 pz + 4 pz		Brill Lucido	T001300EO
Tappi di finitura per profilo a muro	1 dx + 1 sx		Bianco Brill Lucido	T001290AC T001290EO
Tappi per profilo verticale Connect A e R	2 pz		Bianco Brill Lucido	T001291AC T001291EO
Tappi di finitura per profilo verticale Connect PS	1 dx + 1 sx		Bianco Brill Lucido	T001307AC T001307EO
Tappi di finitura per profilo verticale Connect PSC	1 dx + 1 sx		Bianco Brill Lucido	T001309AC T001309EO
Tappi di finitura per profilo verticale Connect P	1 dx + 1 sx		Bianco Brill Lucido	T001310AC T001310EO
Tappi di finitura per profilo angolare Connect L	1 dx + 1 sx		Bianco Brill Lucido	T001312AC T001312EO
Giunzione ad angolo per Connect A	2 coperchi + 2 giunzioni		Bianco Brill Lucido	T001294AC T001294EO
Guarnizione magnetica	una coppia h = 190 cm			T001320NU
Guarnizione gocciolatoio Connect PV	1 pz h = 100 cm			T001318NU
Guarnizione gocciolatoio Connect PS	1 pz h = 100 cm			T001319NU
Guarnizione verticale di contenimento Connect PS	2 pz h = 190 cm			T001226NU
Set fermaporta per Connect A, PSC e R	2 pz		Bianco Brill Lucido	TV597AC TV597EO

Cabine doccia

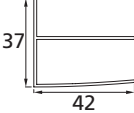
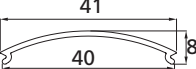
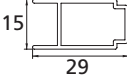
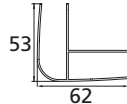
**Tipica**

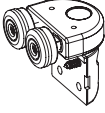
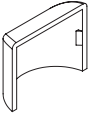

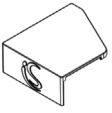

DISPONIBILE SINO AD ESAURIMENTO SCORTE

Descrizione	Note	Disegno	Colore	Codice
Profilo verticale di fissaggio a muro	1 pz h = 185 cm		Bianco Silver Brill	T000354AC T000354YB
Profilo copriviti (Carter)	1 pz h = 190 cm		Bianco Silver Brill	T1948AC T1948YB
Profilo aggiuntivo di allungamento 25 mm	1 pz h = 185 cm		Bianco Silver Brill	T2196AC T2196YB
Profilo giunzione ad angolo Tipica L	1 pz h = 185 cm		Bianco Silver Brill	T000736AC T000736YB
Cuscinetto Tipica A, PSC	4 pz		Bianco Grigio	T000346AC T000346YB
Cuscinetto Tipica R	2 sup + 2 inf		Bianco Grigio	T000345AC T000345YB
Copertura cuscinetto per Tipica R	8 pz		Bianco Grigio	T2023AC T2023YB
Maniglia interasse 19,2 cm	1 pz		Cromo	T182067
Tappi di finitura per profilo a muro	1 dx + 1 sx		Bianco Silver Brill	T001401AC T001401YB

Cabine doccia

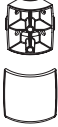
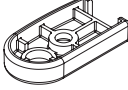
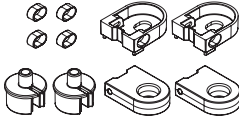
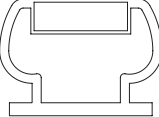
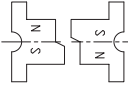
# Tipica

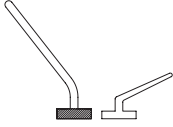
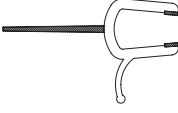
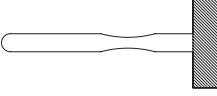
DISPONIBILE SINO AD ESAURIMENTO SCORTE

Descrizione	Note	Disegno	Colore	Codice
Giunzione ad angolo per Tipica A	2 sup + 2 inf		Bianco Silver Brill	T000347AC T000347YB
Blocco cerniera Tipica PS	1 dx + 1 sx		Bianco Silver Brill	T001197AC T001197YB
Blocco cerniera Tipica V1	1 pz		Bianco Silver Brill	T001199AC T001199YB
Guarnizione magnetica Tipica R, A, PSC	una coppia h = 190 cm		Bianco Grigio	T208167 T2081DZ
Guarnizione magnetica Tipica PV	una coppia h = 190 cm			T001196NU
Guarnizione verticale rigida	una coppia h = 190 cm		Bianco Silver Brill	T2090AC T2090YB
Guarnizioni verticali Tipica V1	1 set			T001200NU
Guarnizione gocciolatoio Tipica V1	1 pz h = 80 cm			T001201NU
Pinna removibile tenuta acqua Tipica PV - h = 12 mm	1 pz h = 100 cm			T181167
Confezione completa di montaggio Tipica R (maniglia inclusa)			Bianco Silver Brill	T000352AC T000352YB
Confezione completa di montaggio Tipica A (maniglia inclusa)			Bianco Silver Brill	T000353AC T000353YB
Confezione viti e tasselli per fissaggio				T212667



Ideal Standard